

Manual – Technical Documentation



Watson-Marlow
MasoSine-PUMP
MR 160

Pump-No.:

14661 0909

Contents

Technical datasheet	4
1 GENERAL	5
2 PURPOSE	5
3 FUNCTIONING PRINCIPLE	5
4 SAFETY INSTRUCTIONS	5
4.1 Basic safety instructions	5
4.2 Safety symbols	5
4.3 Obligation of the operator	5
4.4 Organizational measures	5
4.5 Obligation of the personnel	6
4.6 Training of the personnel	6
4.7 Informal safety measures	6
4.8 Dangers when handling the machine	6
4.9 Safety measures in normal operation	6
4.10 Protective devices	6
4.11 Dangers due to hazardous pumped material	6
4.12 Dangers due to electrical energy	6
4.13 Dangers due to hydraulic energy	6
4.14 Special danger points	6
4.15 Constructional changes to the machine	7
4.16 Noise of the machine	7
4.17 Maintenance and repair, troubleshooting	7
4.18 Cleaning the machine	7
4.19 Faults	7
4.20 Use as intended	7
5 WARRANTY AND LIABILITY	7
6 TRANSPORT INSTRUCTIONS	8
7 INSTALLATION	8
8 CONNECTION TO THE PIPING	8
9 POSSIBLE CONNECTION POSITIONS	9
10 CHANGING THE CONNECTION POSITION	9
11 CHANGING THE DIRECTION OF ROTATION	9
12 IMPORTANT: OBSERVE BEFORE START-UP!	10
13 RUNNING DRY	10
14 CLEANING	10
14.1 Cleaning in own circuit with water, alkali, acid	10
14.2 Cleaning in the CIP circuit	11
14.3 Manual cleaning	11
14.4 Sterilization	11

15	OIL CHANGE	11
16	DISPOSAL	12
17	SPARE PARTS	12
18	TAKING OUT OF SERVICE.....	12
18.1	Provisional taking out of service.....	12
18.2	Final putting out of service	12
19	TROUBLESHOOTING	13
20	ADJUSTING DIMENSION.....	15
21	ASSEMBLY.....	16
22	DRAWINGS / STOCK LISTS	19

Technical datasheet

Please remove the all technical information from the technical datasheet.

For spare parts ordering refer to software component list.

If you have problems to identify parts, please refer the drawing and parts list.

1 General

The operating instructions apply for the **WATSON-MARLOW MasoSine-PUMPS** :
MR 160

The operating instructions must be read before installing the pumps. Please observe the safety instructions and the safety regulations.

2 Purpose

The purpose is defined accurately in the order confirmation.

3 Functioning principle

The functioning principle of the **WATSON-MARLOW MasoSine-PUMPS** is ingeniously simple. The pump consists of modular components. Because of the sinusoidal form of the Rotor, a chamber through which the product to be pumped is „pushed through“ or displaced is created four times per revolution when running through the Stator space.

As soon as a chamber closes, the opposite chamber opens by the same fraction of a millimeter as the closing chamber is contracted.

A suction and pressure characteristic of the pump free of pulsation results. The Scraper prevents the pressure compensation of the pressure to the suction side. At the same time the Scraper undertakes the important function of forced lubrication of the pump bearings, or when the pump is cleaned the intensive purging of the bearing or of the seal.

4 Safety instructions

4.1 Basic safety instructions

A basic requirement for safe handling and troublefree operation of this machine is knowledge of the basic safety instructions and of the safety regulations.

These operating instructions contain the most important instructions to operate the machine safely.

These operating instructions, especially the safety instructions, must be observed by all persons who work on the machine.

Moreover the rules and regulations for accident prevention applicable at the place of use must be complied with.

The following safety instructions must be observed absolutely.

They are an essential and indispensable part of the user documentation. Non-compliance can result in loss of warranty claims.

It is recommended in the interest of all involved to enter all installation measures, maintenance, fault and repair cases, training courses, instructions and special occurrences in a logbook assigned to the machine.

4.2 Safety symbols



Safety instruction which can cause danger for persons if not complied with



Safety instruction for electrical voltage



Safety instruction which can cause danger for the pump and its function if not complied with.

4.3 Obligation of the operator

The operator obligates himself to let only persons who are familiar with the basic regulations concerning working safety and accident prevention and are instructed in handling the machine, as well as have read, understood and confirmed by their signature the warning notes in these operating instructions to work on the machine.

The safety-conscious working of the personnel will be checked at regular intervals.

4.4 Organizational measures

The required personal protective equipment shall be provided by the operator.

All existing safety devices shall be checked regularly.

4.5 Obligation of the personnel

All persons who are authorized to work on the machine obligate themselves to observe the basic regulations concerning working safety and accident prevention before starting work, to read the safety chapter and the warning notes in these operating instructions and to confirm by their signature that they have understood these.

4.6 Training of the personnel

Only trained and instructed personnel may work on the machine. The responsibilities of the personnel shall be defined clearly for assembly, start-up, operation, setting, maintaining and repairing.

Personnel under training may work on the machine only under supervision of an experienced person.

4.7 Informal safety measures

The operating instructions must be kept constantly at the place of use of the machine. The generally valid as well as the local regulations for accident prevention and environmental protection shall be provided and observed in addition to the operating instructions. All safety and danger warnings on the machine shall be kept in legible condition.

4.8 Dangers when handling the machine

The WATSON-MARLOW MasoSine-PUMPS is built according to the state of the art and the recognized safety engineering rules. Nevertheless danger to life and limb of the user or third persons or impairments to the machine or to other assets can arise in its use. The machine must be used only:

- for the intended use (see technical datasheet)
- in perfect safety engineering condition.

Faults which can impair safety must be rectified immediately.

4.9 Safety measures in normal operation

Operate the machine only if all protective devices are fully functioning. Before switching the machine on make sure that no one can be endangered by the starting machine. At least once per shift inspect the machine for "externally detectable damage" and for functioning of the safety devices.

4.10 Protective devices

All protective devices must be attached correctly and functioning before every start-up.

Protective devices may be removed only

- after standstill **and** simultaneous protection against restarting the machine.
- On delivery of part components the protective devices must be attached according to regulations by the operator. If hot or cold machine parts can lead to danger, these must be protected by the operator on site against contact.

4.11 Dangers due to hazardous pumped material

In the case of hazardous pumped material (according to ArbStoffV) the corresponding regulations must be complied with.

4.12 Dangers due to electrical energy



Have work on the electrical supply performed only by an electrician. Check the electrical equipment of the machine regularly. Rectify loose connections and scorched cables immediately.

Keep the control cabinet closed always. Access is allowed only to authorized personnel with key or tool.

If work on parts conducting voltage is necessary, call in a second person who switches off the main switch if necessary.

**If you make the electrical connection of the pump, act according to DIN EN 60204!
Connect only by skilled personnel!**

4.13 Dangers due to hydraulic energy

Only personnel with special knowledge and experience in hydraulics may work on hydraulic devices.

Relieve the pressure in system sections and pressure lines to be opened before starting repair work. Replace hydraulic hose lines at appropriate intervals, even if no safety-relevant defects are detectable.

4.14 Special danger points

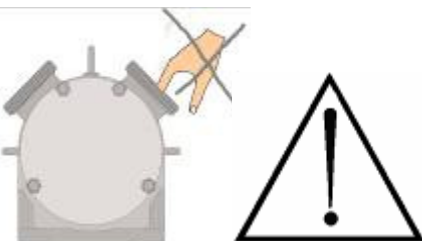

Rotating rotor in the pump. Danger of crushing or cutting off fingers and hands. The pump must be protected by the customer so that it is not possible for persons to grasp in the opening with the rotor running. In the case of work on the stationary Rotor, the drive must be secured against unintentional switching on. Increased danger exists with dismantled pipes and opened pump.

4.15 Constructional changes to the machine

Make no changes, attachments or conversions to the machine without approval of the manufacturer. All conversion measures require a written confirmation of the MASO company. Immediately replace machine parts in not perfect condition. Use only original spare and wearing parts. In the case of parts not obtained from MASO it is not guaranteed that they are designed and manufactured in compliance with load and safety requirements.

4.16 Noise of the machine

The continuous sound pressure level proceeding from the machine is max. 70 dB(A). A higher sound pressure level that causes noise deafness can arise depending upon the local conditions. In this case protect the operating personnel with corresponding protective equipment / protective measures.

4.17 Maintenance and repair, troubleshooting

Perform specified adjustment, maintenance and inspection work on time. Inform operating personnel before starting the maintenance and repair work. Protect all plant parts and operating media connected before and after the machine such as compressed air and hydraulics and similar against unintentional start-up. In all maintenance, inspection and repair work switch the machine free of voltage and secure the main switch against unexpected switching back on. Fasten and secure larger assemblies on replacement carefully to lifting gear. Check loosened screw connections for firm seating. Use only original spare parts.



After ending the maintenance work check the safety devices for function.

4.18 Cleaning the machine

Handle substances and materials used correctly, especially

- when working on lubricating systems
- when cleaning with solvents.

4.19 Faults

In the case of operating faults switch off the machine and secure it against unauthorized or inadvertent starting up again.

4.20 Use as intended

The accurate intention is listed in the order confirmation. Another use or use going beyond this is not as intended.

If you want to change the product, the pressure, the speed or the temperature, you must firstly consult us or one of our representatives.

5 Warranty and liability

Basically our "General sales and delivery conditions" apply.

These are available to the operator at the latest since conclusion of the contract.

Warranty and liability claims for personal and material damage are excluded if they are attributable to one or several of the following causes:

Use of the machine not as intended

Incorrect installation, operation and maintenance of the machine

Operating the machine with defective safety devices or not correctly attached or not functioning safety and protective devices

Non-compliance with the instructions in the operating instructions regarding

transport,

storage,

installation,

start-up,

operation, maintenance and setting of the machine.

Unauthorized constructional changes to the machine

Insufficient monitoring of machine parts subject to wear

Incorrectly performed repairs

Cases of catastrophe due to effect of foreign bodies and acts of God.

WATSON-MARLOW GmbH grants no warranty on this documentation as well as no implicit warranties on commercially customary quality and suitability for a certain application.

WATSON-MARLOW GmbH undertakes no liability for errors contained in it or consequential damage occurring by chance arising due to the design, performance and the use of this documentation.

This publication contains own information protected by copyright. All rights are reserved.

This publication may be neither photocopied, nor duplicated nor translated without previous agreement of **WATSON-MARLOW GmbH**. Rights reserved to make changes in these operating instructions.

6 Transport instructions

The choice of the means of transport is according to the size of the pump and of the drive. The pump must be suspended correctly for transport. The crane/forklift truck and the ropes/belts must be sufficiently dimensioned. If the pump is transported with a lift truck or a forklift truck, it must be noted that the console centre point is not automatically the centre of gravity.

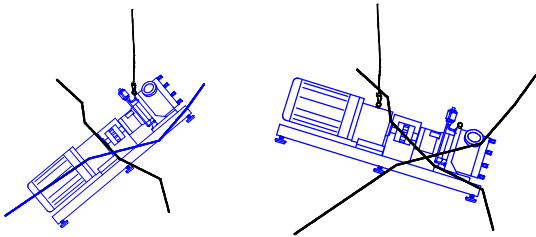

wrong

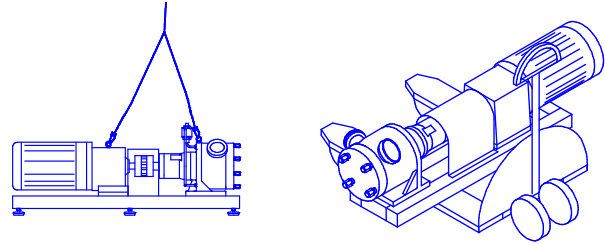

right

7 Installation



The motor shaft and pump shaft connection must be protected against contact!

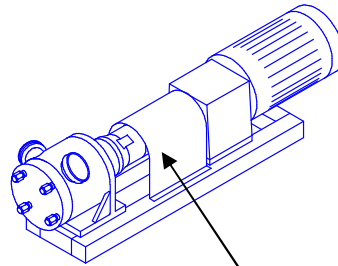

**DO NOT START WITHOUT
PROTECTION AGAINST CONTACT!!**

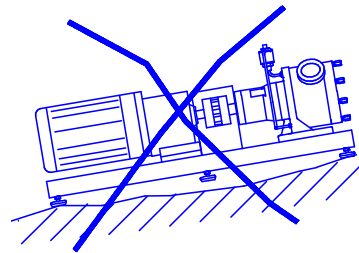

wrong

Place the pump on a level ground.

Do not start without the protection against contact!!

The foundation should be dimensioned sufficiently for the weight of the pump.

There should be sufficient space for maintenance work around the pump.

It must be guaranteed that the motor receives an adequate air supply.

If the pump is used in explosion endangered rooms, an Ex protected motor must be used.

The total unit must be protected against static charge.

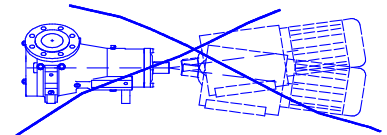

Align the shaft of the pump with the shaft of the drive.

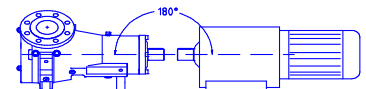

8 Connection to the piping

CAUTION

Before connection clean the piping and remove foreign bodies. (e.g. there can still be residues in the pipes due to welding work).

CAUTION

Fit elastic intermediate members (compensators) between pump and fixed piping on the suction and pressure side. This should prevent vibrations of the pump being transmitted to the piping system.

CAUTION

Forces and torques acting from the piping on the pump connections (e.g. due to distortion, expansion due to temperatures etc.) must be avoided.

CAUTION

The pressure line should point upwards, so that later residual liquid can always flow back into the pump. Thus total dry running is avoided. Further it facilitates the later suction process.

CAUTION

The operator has to ensure that an inadmissible pressure rise (above the pressure agreed in the order and listed in the technical data) is not possible.

CAUTION

The operator has to ensure that the pump can work free of cavitation.

Cavitation destroys the pump

9 Possible connection positions

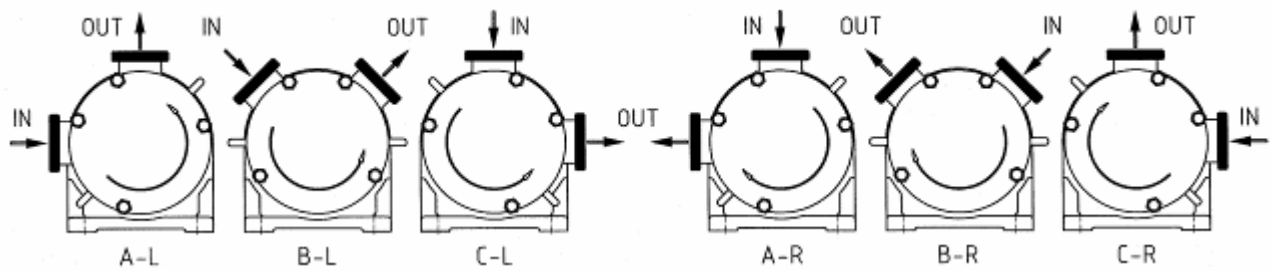

Counterclockwise rotation of the rotor and motor

Clockwise rotation of the rotor and motor

Unless otherwise ordered, the pump is delivered in position B

10 Changing the connection position

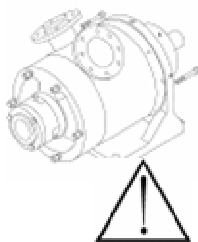

Remove the screws on the bearing block. Turn the housing by an angle of 45° to the left or right. Tighten the screws again. (45 Nm)

However, take care that due to the corresponding arrangement of the pressure line in the pump, a certain residual amount remains. By this measure you make it easier for the pump to draw in highly viscous products. However, in the case of horizontally lying pressure connection you must absolutely take care that the pressure line is run so that the pump is always covered with residual liquid. In this way total dry running is avoided.

When the connection position is changed, the motor must be protected against unintentional switching on!!

11 Changing the direction of rotation

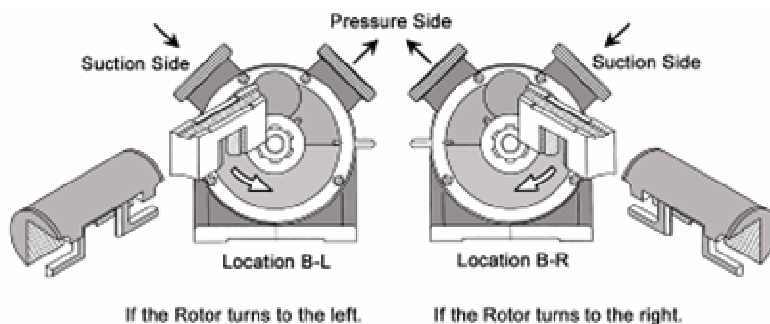

The suction or the pressure side changes on changing the direction of rotation of the drive. Then the **Scraper** and the **Scraper gate guide** must **absolutely** be turned, since otherwise the pump cannot bring its full output. If the direction of rotation is changed, the rotation direction arrows must be turned correspondingly. Further the suction or pressure connection must be marked. The set direction of rotation is stated by an arrow. The pump can run against the set direction only for a short time. It cannot build up more than 2 bar pressure if the direction of rotation is wrong.



Let the change of direction of rotation on the drive be made only by trained skilled personnel. The motor must be protected against unintentional switching on!

12 Important: Observe before start-up!

If you have performed cleaning or repair work or make the first start-up, check before start-up that all screws are correctly and completely tightened.



Observe the corresponding regulations in the case of hazardous pumped material (according to ArbStoffV).

CAUTION

Before the first start-up fill with water or pumped material to avoid dry running and to facilitate the suction process.

CAUTION

The pump is proof against dry running only as long as the heat resistance of the seals is guaranteed. This is approx. 1 minute under the most unfavourable conditions – as with maximum speed.

The pressure line should point upwards so that residual liquid can always flow back into the pump later. This avoids total dry running. Further it facilitates the later suction process.



The motor must be connected by an expert according to DIN EN 60204.

The pump can possibly be contaminated by transport, therefore remove the pump cover and clean if necessary before start-up.

Before you start up the pump, convince yourself once again that the Scraper and the Scraper gate guide are in the correct position in relation to the pressure side (see change of direction of rotation).

Connect the purging

CAUTION

Make sure before start-up that all valves on the pressure and suction side are open. The pump may not pump against a closed valve without overpressure valve.

CAUTION

If the pump leaks, end operation as quickly as possible to replace the damaged sealing elements.

CAUTION

The operator must ensure that the pump can work free of cavitation.
Cavitation destroys the pump.

13 Running dry

The pump is proof against running dry only as long as the heat resistance of the seals is guaranteed. This is approx. 1 minute under most unfavourable circumstances – such as at maximum speed.

CAUTION

If you have a pump with a Mechanical Seal System:
A pump with a Mechanical Seal may never run dry!

Purging should be without pressure, this means that the purging water runs out from the purging system without pressure (thumb test: it must be possible to stop water with the thumb).

14 Cleaning

All WATSON-MARLOW MasoSine-PUMPS are fully capable of CIP cleaning. Please observe our CIP cleaning regulations.

14.1 Cleaning in own circuit with water, alkali, acid

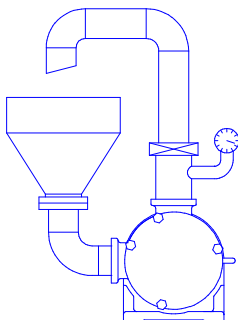

1. Set control gear to maximum speed (at least 400 rpm).
2. Choke after the pump so that a counterpressure of 3 to 4 bar arises.
3. Should the required cleaning effect not be achieved after this process, it is necessary to dismantle the pump. This is done in a few minutes as described in detail in the operating instructions.

Manual cleaning of the pump can be performed after complete dismantling of the pump.
Pay attention to parts sensitive to breakage!!

14.2 Cleaning in the CIP circuit

Back to the plant

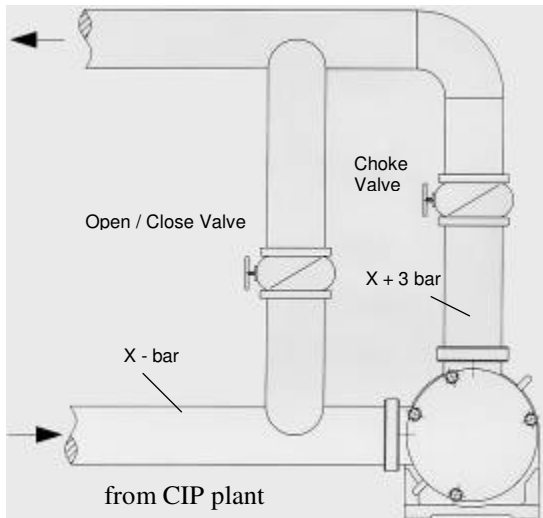

1. Purging surge

Open the choke valve and let the **WATSON-MARLOW MasoSine-PUMPS** run with maximum speed to perform the first rough cleaning.

2. Purging

Set the choke valve so that the pressure side of the pump is at least 3.0 bar higher than the suction side.

Open the open/close valve to guarantee cleaning of the series connected devices.

14.3 Manual cleaning

Manual cleaning of the pump can be performed after complete dismantling of the pump.

Pay attention to parts sensitive to breakage!!



If the pump is stopped during the process and opened for the purpose of cleaning or checking, the responsible fitter or electrician must be notified to undertake suitable measures so that the pump cannot be put into operation (remove fuses, notify electrician).



The pump may also never be put into operation if the housing cover is removed. Should the pump not yet be connected to the piping system, then reliable care must be taken that the drive machine cannot be switched on.

Observe the accident prevention regulations!!

14.4 Sterilization

Sterilisation of the pump with standard equipment is possible **up to 110°C only in standstill!**

In the case of special equipment of the pump or higher temperatures, please always firstly consult the manufacturer!

15 Oil change

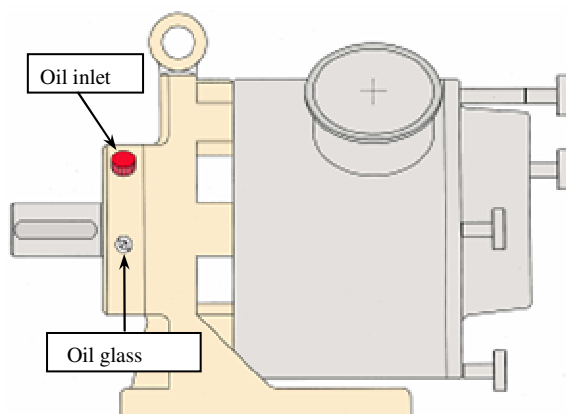

The oil must be changed once yearly or every 1500 operating hours for the pumps of the series **MR 160**. The standard operation for changing oil would be to loosen all four bolts on the bearing housing cover (Pos. 21) and all parts should be removed (bolts and cover). At this point the used oil can be drained. After that the bearing housing cover has to be replaced and the bolts would be retighten. The oil sight glass in the bearing block should be filled up to the middle. (ca 0.3 Liter). Please use the following oil grade or similar:

*** (Standard first filling of the **WATSON-MARLOW MasoSine-PUMPS**)***

Klüberoil 4 UH 1-220 N (lubricating oil for the food and pharmaceutical industry)

Our standard first filling is only suitable for temperatures above -10°C .

If you come below -10°C you must replace the oil !

16 Disposal

Send the old oil for treatment.

17 Spare parts

Basically repairs should be performed only by factory personnel or by customer service agencies authorized by the factory. If you make repairs yourself, observe the relevant safety regulations and contact the factory customer service before starting the work, especially if warranty obligations which can be lost by not approved repairs still exist.

Only WATSON-MARLOW-ORIGINAL-SPARE-PARTS may be used.

If you make changes to the equipment, e.g. instead of O-rings made of Perbunan those from EPDM, or another sealing system, please note this on the maintenance plan.

Please provide all data when ordering:

- EDP number
- Designation of the part
- Material of the part
- The drawing / parts list number
- Quantity
- **Ask for our express delivery!**

WATSON-MARLOW GmbH Postfach 100 STEINBEISSTR. 3 D-74358 ILSFELD (GERMANY) TELEPHON : +49 7062 9560-0 TELEFAX : +49 7062 64593 EMail Info@masosine.de Internet http://www.masosine.de
--

18 Taking out of service

18.1 Provisional taking out of service

Short term:

Remove product residues (cleaning) ⇒ Switch off main switch ⇒ Clean pump surface

Longer term:

Remove product residues carefully (cleaning) ⇒ Switch off main switch ⇒ Clean pump surface ⇒ Disconnect connections ⇒ Drain off static purging liquid ⇒ Loosen purging connections ⇒ Store the scraper in water.

18.2 Final putting out of service

Separate power and purging liquid supply. Send oils and greases for treatment.

If you send us the remaining parts freight paid, we will dispose of the parts.

19 Troubleshooting

Error	Cause	Remedy
<i>Pump does not draw in</i>	Direction of rotation not correct	Check direction of rotation
	No wetting liquid in the pump	Fill pump with liquid
	Screw fastening not tight	Check screw fastening
	Suction pipe too long	Adapt suction pipe
	Pipe cross-section too narrow	Adapt suction pipe
	Shaft seal leaking	Check all seals for damage
	Wear in the pump	Change wearing parts
	Motor speed not correct	Measure, regulate speed
	Scraper and cartridge wrongly inserted	Check position (see changing direction of rotation)
<i>Pump does not deliver</i>	Direction of rotation not correct	Check direction of rotation
	Suction and pressure pipe confused	Check pipe system
	Motor speed not correct	Check speed based on output diagrams
	Wearing parts worn	Replace wearing parts
	Scraper and cartridge wrong	Check position (see changing direction of rotation)
	Inserted closed gate valve	Check pipe system
<i>Pump is noisy</i>	Noises come from the drive	Consult WATSON-MARLOW
	Noises come from the pump	Consult WATSON-MARLOW
	Suction pipe too small (cavitation)	Shorten suction pipe or increase diameter, reduce speed
	Knocking noises from the pump head	Gate valve wear
	Noises from bearing block	Fill oil, change tapered roller bearings
	Coupling not aligned	Align coupling with hairline
<i>Pump leaking at leakage hole</i>	Shaft seal leaking	Change GLRD or radial shaft sealing rings
	O-ring seal leaking	Replace O-ring
	Radial shaft sealing ring on the bearing block leaking, oil escapes	Dismantle bearing block, replace radial shaft sealing rings
<i>Pump leaking at the front housing</i>	Housing seal not or wrongly installed	Install housing O-ring correctly or replace
	Housing seal defective	Install housing O-ring correctly or replace

Error	Cause	Remedy
<i>Pump has blocked</i>	Foreign body in the pump	Remove foreign body, examine pump for damage
	Power supply interrupted	Check electrical installations (fuses), check drive
	Defect on the drive	(Separate the coupling and turn the pump by hand)
<i>Strong wear after short operating time</i>	Solids in the pumped material Pumped material is abrasive	Frequent change of the wearing parts, change material pairing Choose larger pump, reduce speed
<i>Rotor has wear on one side</i>	Rotor not tightened correctly on installation	Tighten closing nut firmly on block
	Adjusting dimensions changed after working on the bearing block	Check and correct the adjusting dimensions MR 160 = 35.6mm +0.1
<i>Pump not clean after CIP cleaning</i>	Cleaning regulation not complied with	Choke on the pressure side Check differential pressure 3-4 bar
<i>Rotor has seized on Liners</i>	Rotor not correctly tightened	Tighten closing nut firmly on block
	Temperature too high (thermal expansion)	Choose Liners with larger tolerances
<i>Purging between housing and bearing block leaking</i>	O-ring in the bearing block missing or defective	Install or replace O-ring
<i>Water or pumped material in the bearing block</i>	Purging pressure too high	Purging must be pressureless (attach pressure reducer, max. 0.1 bar)
	Leakage bores closed	Check leakage bores for free passage, replace shaft seals on pump and bearing block
<i>Front bearing has seized on rotor</i>	O-ring in the front bearing missing or worn	Install or replace O-ring
	Front bearing wrongly installed	Examine front bearing for damage and install in correct position

20 Adjusting dimension

The Adjusting dimension will be measured at point X 35.6mm +0.1 (see diagnostic help page 14)

If the dimension is too small, you have to turn the Adjusting ring.

If the dimension is too big, please contact the company MASO and order a new Adjusting ring.

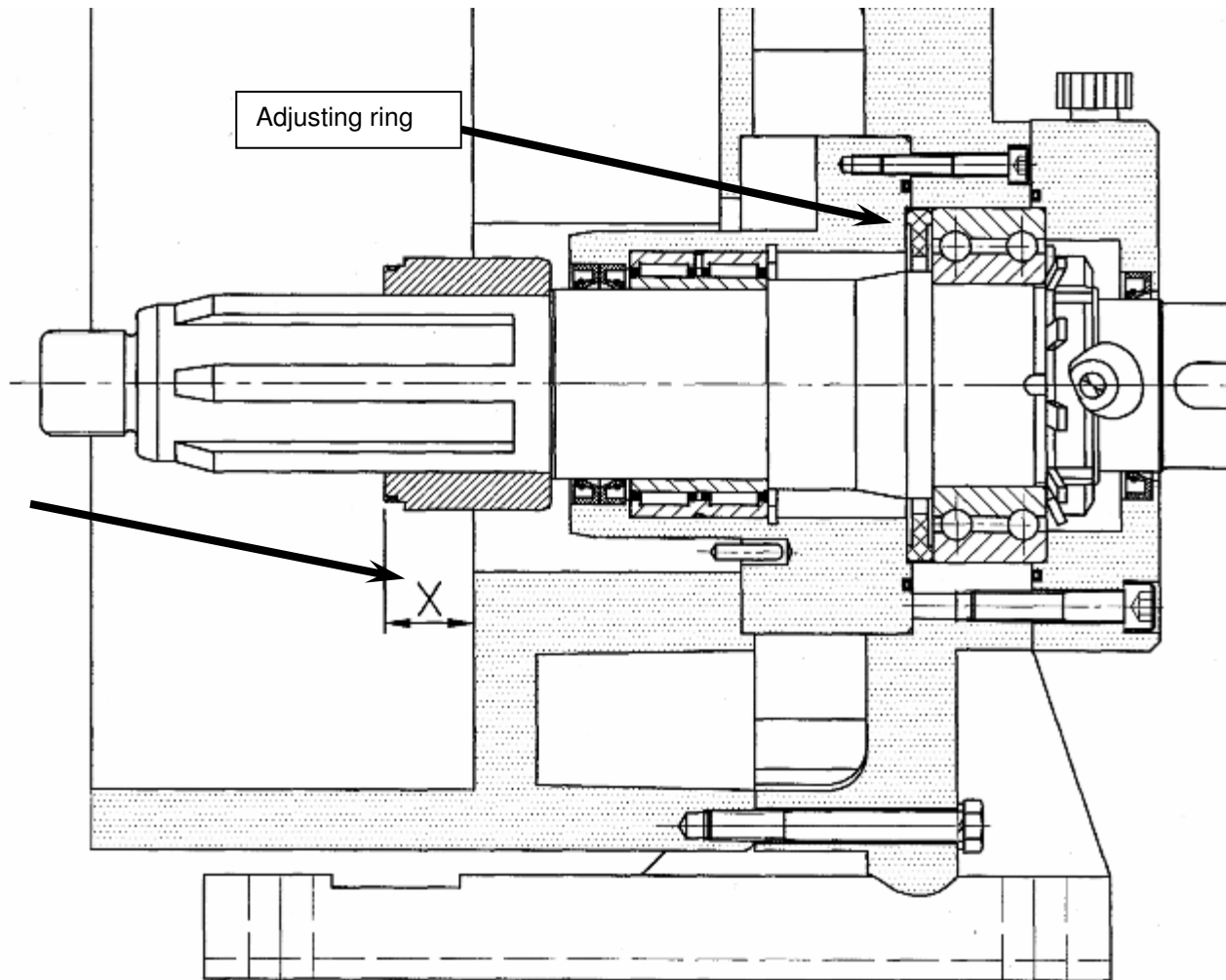

21 Assembly

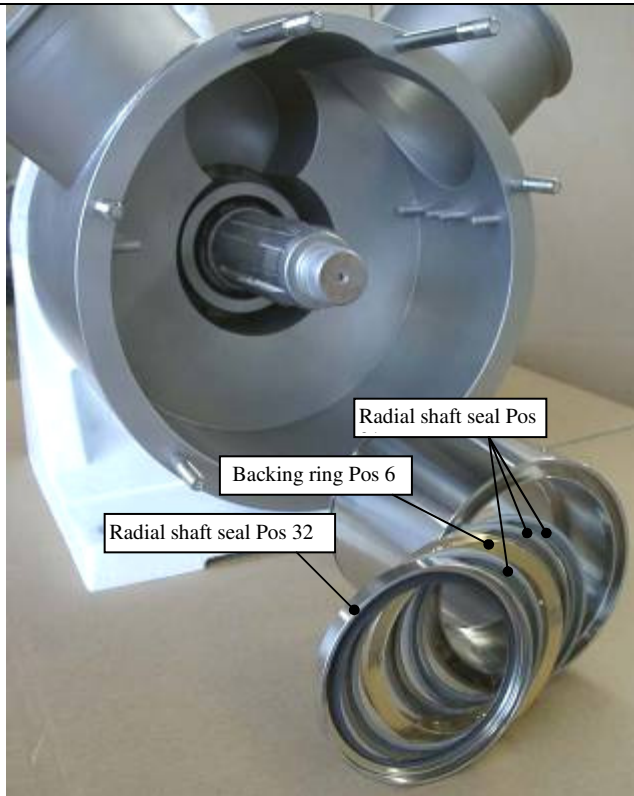

The pin has to be fixed in the groove in the pump housing
The seal housing push up to notice



During the right run the scraper gate guide and Scraper have to be turned!

See page 9 chapters 11 "changing the direction of rotating"



tighten the locking nut with the torque of 160 Nm



Install the Scraper gate guide, Scraper and Rotor as a unit



The pin of the front bearing has to be fixed of the groove in the front cover

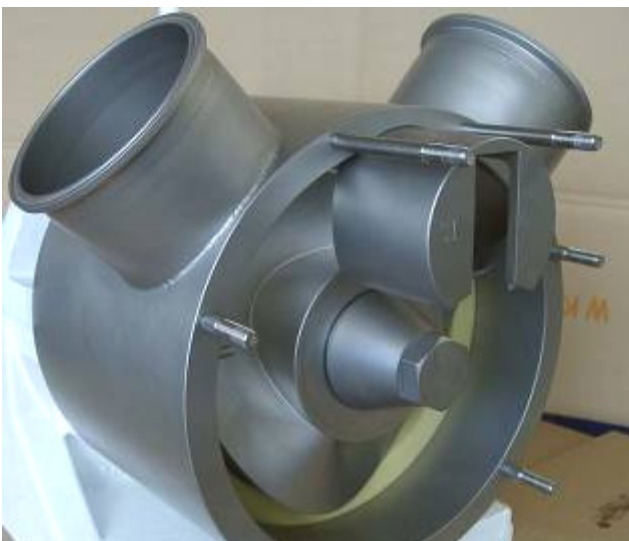

Take care during all works that the O-rings will be assembled completely and without any damage.

If you have questions, call us. We will happy to help.

WATSON-MARLOW GmbH
Postfach 100
STEINBEISSTR. 3
D-74358 ILSFELD (GERMANY)
Telefon (07062) 9560-0
Telefax (07062) 64593
eMail Info@masosine.de
Internet <http://www.masosine.de>

22 Drawings / Stock lists